

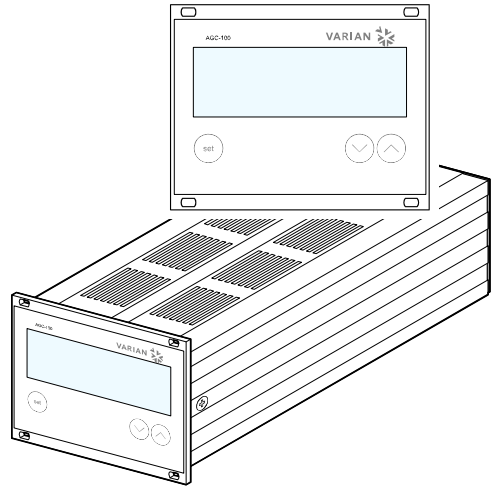

# Vacuum Gauge Controller

## AGC-100



## Product Identification

In all communications with VARIAN, please specify the information on the product nameplate. For convenient reference reference copy that information into the space provided below:

VARIAN Lexington MA 02421 USA	
Model: .....	
PN: .....	
SN: .....	
.....V.....Hz.....VA	
Made in Liechtenstein	

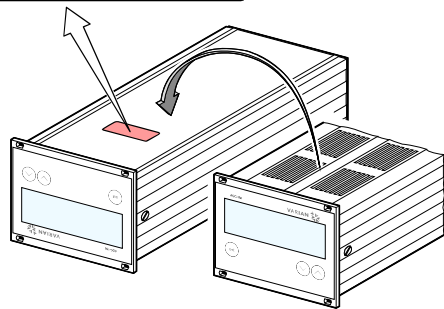

## Validity

This document applies to products with part number AGC100.

The part number (PN) can be taken from the product nameplate.

This document is based on firmware number 302-564--. If your unit does not work as described in this document, please check that it is equipped with the above firmware version (→  43).

We reserve the right to make technical changes without prior notice.

All dimensions are indicated in mm.

**Intended Use**

The Vacuum Gauge Controller AGC-100 is used together with VARIAN gauges for total pressure measurement. All products must be operated in accordance with their respective Operating Manuals.



**Scope of Delivery**

- 1× Single-Channel Controller
- 1× Power cord
- 1× Rubber bar
- 2× Rubber feet
- 4× Collar screws
- 4× Plastic sleeves

**Contents**

Product Identification	2
Validity	2
Intended Use	3
Scope of Delivery	3
<b>1 Safety</b>	<b>6</b>
1.1 Symbols Used	6
1.2 Personnel Qualifications	6
1.3 General Safety Instructions	7
1.4 Liability and Warranty	8
<b>2 Technical Data</b>	<b>9</b>
<b>3 Installation</b>	<b>13</b>
3.1 Personnel	13
3.2 Installation, Setup	13
3.2.1 Rack Installation	13
3.2.2 Installation in a Control Panel	18
3.2.3 Use as Desk-Top Unit	19
3.3 Mains Power Connector	20
3.4 SENSOR Connector	21
3.5 CONTROL Connector	22
3.6 RS232 Interface Connector	24
<b>4 Operation</b>	<b>25</b>
4.1 Front Panel	25
4.2 Turning the AGC-100 On and Off	26
4.3 Operating Modes	26
4.4 Measurement Mode	27
4.5 Parameter Mode	29
4.5.1 Parameters	31
4.6 Test Mode	41
4.6.1 Parameters	43
4.6.2 Test Programs	44
<b>5 Communication (Serial Interface)</b>	<b>49</b>
5.1 RS232C Interface	49
5.1.1 Data Transmission	49
5.1.2 Communication Protocol	51
5.2 Mnemonics	53
5.2.1 Measurement Mode	54
5.2.2 Parameter Mode	57
5.2.3 Test Mode	63
5.2.4 Example	68
<b>6 Maintenance</b>	<b>69</b>
<b>7 Troubleshooting</b>	<b>70</b>
<b>8 Repair</b>	<b>72</b>

<b>9 Accessories</b>	<b>72</b>
<b>10 Storage</b>	<b>72</b>
<b>11 Disposal</b>	<b>73</b>
<b>Appendix</b>	<b>74</b>
A: Conversion Tables	74
B: Default Parameters	75
C: Firmware Update	76
D: Literature	79
E: Index	80
<b>EC Declaration of Conformity</b>	<b>82</b>

For cross-references within this document, the symbol (→  XY) is used, for cross-references to further documents listed under "Literature", the symbol (→  [Z]).

# 1 Safety

## 1.1 Symbols Used

Symbols for residual risks

**DANGER**

Information on preventing any kind of physical injury.

**WARNING**

Information on preventing extensive equipment and environmental damage.

**Caution**

Information on correct handling or use. Disregard can lead to malfunctions or minor equipment damage.

Further symbols



The lamp/display is lit.



The lamp/display flashes.



The lamp/display is dark.



Press the key (example: 'para' key).



Do not press any key

## 1.2 Personnel Qualifications



**Skilled personnel**

All work described in this document may only be carried out by persons who have suitable technical training and the necessary experience or who have been instructed by the end-user of the product.

### 1.3 General Safety Instructions

Adhere to the applicable regulations and take the necessary precautions for all work you are going to do and consider the safety instructions in this document.

STOP
DANGER



**DANGER: mains voltage**

Contact with live parts is extremely hazardous when any objects are introduced or any liquids penetrate into the unit.

Make sure no objects enter through the louvers and no liquids penetrate into the equipment.

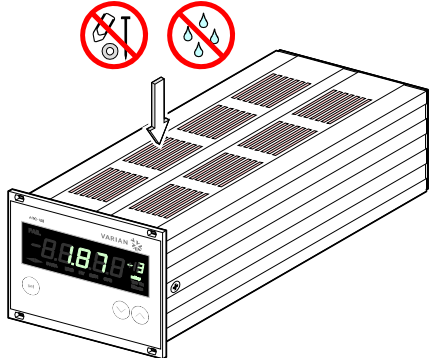

#### Disconnecting device

The disconnecting device must be readily identifiable and easily reached by the user. To disconnect the controller from mains, you must unplug the mains cable.

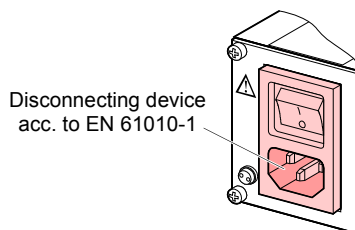

Communicate the safety instructions to all other users.



## 1.4 Liability and Warranty



VARIAN assumes no liability and the warranty becomes null and void if the end-user or third parties









- disregard the information in this document
- use the product in a non-conforming manner
- make any kind of interventions (modifications, alterations etc.) on the product
- use the product with accessories not listed in the corresponding documentation.



## 2 Technical Data

Mains specifications	Voltage Frequency Power consumption Overvoltage category Protection class Connection	90 ... 250 VAC 50 ... 60 Hz ≤30 VA II 1 European appliance connector IEC 320 C14
Ambient conditions	Temperature Storage operation Relative humidity  Use  Pollution degree Degree of protection	-20 ... +60 °C + 5 ... +50 °C ≤80% up to +31 °C, decreasing to 50% at +40 °C  indoors only max. altitude 2000 m NN  II IP 30
Compatible gauges	Number Compatible types Pirani Pirani/Capacitive Cold cathode/Pirani Hot cathode/Pirani Capacitive	1  PVG (PVG-500, PVG502) PCG (PCG-750, PCG752) FRG (FRG-700, FRG-702) FRG (FRG-720, FRG-730) CDG (CDG-500)
Gauge connections	Number   SENSOR connector	2 (parallel)  <div style="background-color: yellow; padding: 5px; border: 1px solid black; margin-bottom: 10px;">  <b>Caution</b> </div> Do not connect more than one gauge at the same time. 15-pin D-Sub, female RJ45 (FCC68), female (pin assignment →  22)
Operation	Front panel HOST (remote control)	via 3 keys via RS232C interface

Measurement values	Measurement ranges	depending on gauge (→  [1] ... [6])
	Measurement error	
	gain error	≤0.02% FSr
	offset error	≤0.05% FSr
	Measurement rate	
	analog	100 / s
	digital	50 / s (FRG-720, FRG-730, CDG-500)
	Display rate	10 / s
	Filter time constant	
	slow	750 ms ( $f_g = 0.2$ Hz)
	normal (nor)	150 ms ( $f_g = 1$ Hz)
	fast	20 ms ( $f_g = 8$ Hz)
	Pressure units	mbar, Pa, Torr, Micron
Zero adjust	for linear gauges	
Correction factor	for logarithmic gauges 0.10 ... 10.00	
A/D converters	resolution >0.001% FSr (The measurement values of FRG-720, FRG-730 and CDG-500 are transmitted digitally.)	
Gauge supply	Voltage	+24 VDC ±5%
	Current	750 mA
	Power consumption	18 W
	Fuse protection	900 mA with PTC element, self-resetting after turning the AGC-100 off or disconnecting the gauge
Switching function	Number	1
	Reaction delay	≤10 ms if switching threshold close to measurement value (for larger differences con- sider filter time constant).
	Adjustment range	depending on gauge (→  [1] ... [6])
	Hysteresis	≥1% FSr for linear gauges ≥10% of measurement value for logarithmic gauges

Switching function relay	Contact type	floating changeover contact
	Load max.	125 VAC, 60 W (ohmic) 110 VDC, 2 A, 60 W (ohmic)
		
		For benchtop use, max. 30 VAC or 60 VDC may be connected.
	Service life	
	mechanic	10 <sup>8</sup> cycles
	electric	10 <sup>5</sup> cycles (at maximum load)
	Contact positions	→  23
	CONTROL connector	9-pin D-Sub, male (pin assignment →  23)
Error signal	Number	1
	Reaction time	≤20 ms
Error signal relay	Contact type	floating normally open contact
	Load max.	125 VAC, 60 W (ohmic) 110 VDC, 2 A, 60 W (ohmic)
		
		For benchtop use, max. 30 VAC or 60 VDC may be connected.
	Service life	
	mechanic	10 <sup>8</sup> cycles
	electric	10 <sup>5</sup> cycles (at maximum load)
	Contact positions	→  23
	CONTROL connector	9-pin D-Sub, male (pin assignment →  23)
Analog output	Number	1
	Voltage range	0 ... +10 V
	Internal resistance	660 Ω
	Measurement signal vs. pressure	depending on gauge (→  [1] ... [6])
	CONTROL connector	9-pin D-Sub, male (pin assignment →  23)

Interface	Standard Protocol	RS232C ACK/NAK, ASCII with 3-character mnemonics, bi-directional data flow, 8 data bits, no parity bit, 1 stop bit
	RS232C Transmission rate RS232 connector	only TXD and RXD used 9600, 19200, 38400 baud 9-pin D-Sub, female (pin assignment →  24)

Dimensions [mm]

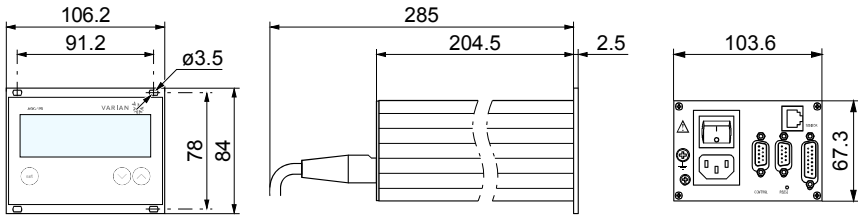

Use For incorporation into a rack or control panel or as desk-top unit

Weight 0.85 kg

## 3 Installation

### 3.1 Personnel



**Skilled personnel**



The unit may only be installed by persons who have suitable technical training and the necessary experience.

### 3.2 Installation, Setup

The AGC-100 is suited for incorporation into a 19" rack or a control panel or for use as desk-top unit.



**DANGER**



**DANGER: damaged product**  
 Putting a damaged product into operation can be extremely hazardous.  
 In case of visible damages, make sure the product is not put into operation.

#### 3.2.1 Rack Installation

The AGC-100 is designed for installation into a 19" rack chassis adapter according to DIN 41 494. For this purpose, four collar screws and plastic sleeves are supplied with it.



**DANGER**



**DANGER: protection class of the rack**  
 If the product is installed in a rack, it is likely to lower the protection class of the rack (protection against foreign bodies and water) e.g. the EN 60204-1 regulations for switching cabinets.  
 Take appropriate measures for the rack to meet the specifications of the protection class.

Guide rail

In order to reduce the mechanical strain on the front panel of the AGC-100, preferably equip the rack chassis adapter with a guide rail.

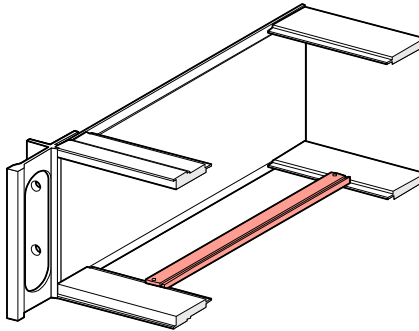

Slide rails

For safe and easy installation of heavy rack chassis adapters, preferably equip the rack frame with slide rails.

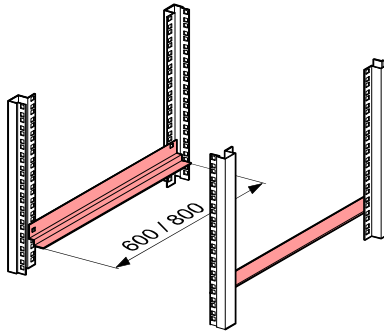

## Mounting height

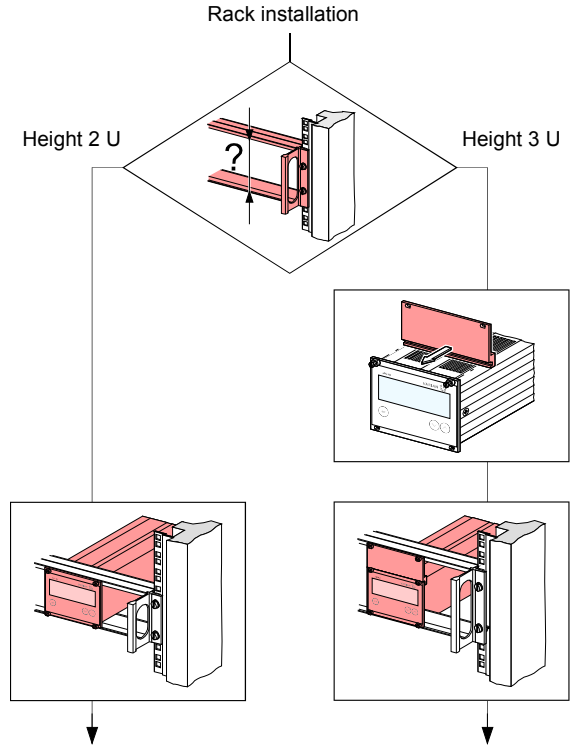

## Height 2 U rack chassis adapter

- 1 Secure the rack chassis adapter in the rack frame.



The admissible maximum ambient temperature (→ 9) must not be exceeded neither the air circulation obstructed.

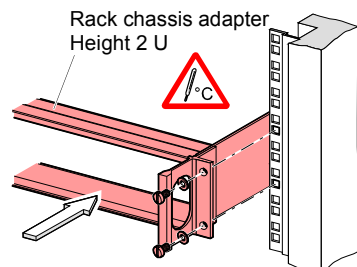

- 2** Slide the AGC-100 into the adapter ...

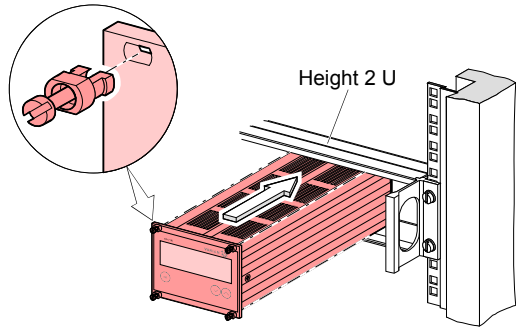

... and fasten the AGC-100 to the rack chassis adapter using the screws supplied with it.

Height 3 U rack chassis adapter

For incorporation into a 19" rack chassis adapter, height 3, an adapter panel (incl. two collar screws and plastic sleeves) is available (→  72).

- 1** Secure the rack adapter in the rack frame.



The admissible maximum ambient temperature (→  9) must not be exceeded neither the air circulation obstructed.

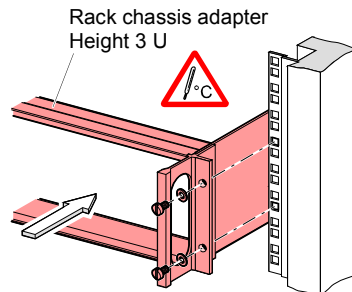



- 2** Mount the adapter panel as upper extension to the front panel of the AGC-100 using the screws supplied with the adapter panel.

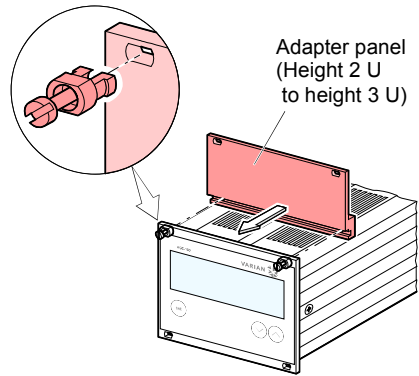

- 3** Slide the AGC-100 into the rack chassis adapter ...

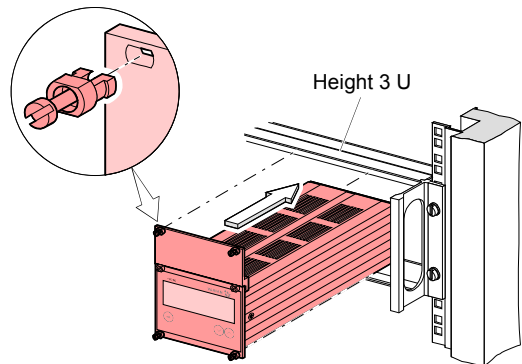

...and fasten the adapter panel to the rack chassis adapter using the screws supplied with the AGC-100.

### 3.2.2 Installation in a Control Panel



**DANGER**



**DANGER:** protection class of the control panel

If the product is installed in a rack, it is likely to lower the protection class of the rack (protection against foreign bodies and water) e.g. according to the EN 60204-1 regulations for switching cabinets.

Take appropriate measures for the control panel to meet the specifications of the protection class.

For mounting the AGC-100 into a control panel, the following cut-out is required:

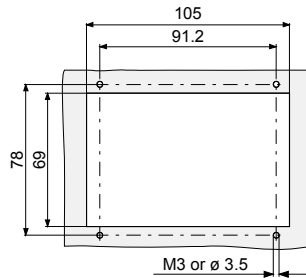

The admissible maximum ambient temperature (→ 9) must not be exceeded neither the air circulation obstructed.

For reducing the mechanical strain on the front panel, preferably support the unit.

- 1** Slide the AGC-100 into the cut-out of the control panel ...

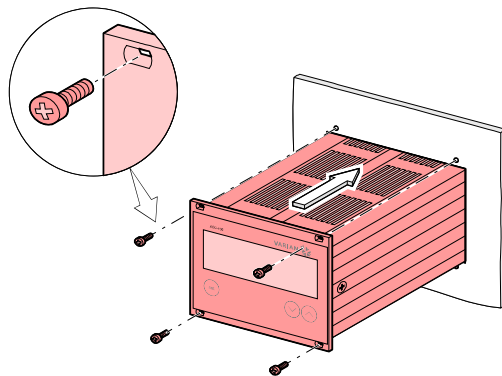

... and secure it with four M3 or equivalent screws.

### 3.2.3 Use as Desk-Top Unit

The AGC-100 is also suited for use as desk-top unit. For this purpose, two self-adhesive rubber feet as well as a slip-on rubber bar are supplied with it.

- 1 Stick the two supplied rubber feet to the rear part of the bottom plate ...

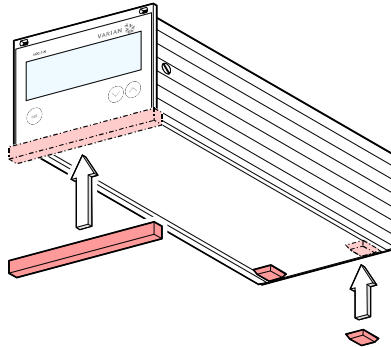



... and slip the supplied rubber bar onto the bottom edge of the front panel.



Select a location where the admissible maximum ambient temperature (→ 9) is not exceeded (e.g. due to sun irradiation).

### 3.3 Mains Power Connector

**DANGER**



**DANGER: line voltage**  
 Incorrectly grounded products can be extremely hazardous in the event of a fault.  
 Use only a 3-conductor power cable (3×1.5 mm<sup>2</sup>) with protective ground. The power connector may only be plugged into a socket with a protective ground. The protection must not be nullified by an extension cable without protective ground.

The unit is supplied with a 2.5 m power cord. If the mains cable is not compatible with your system, use your own, suitable cable with protective ground.

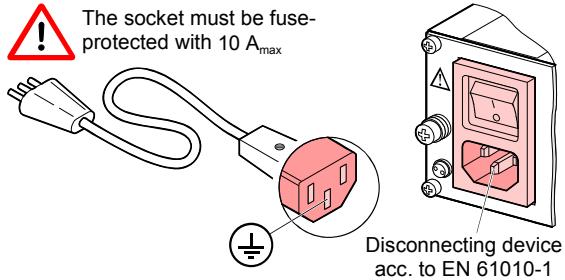

If the unit is installed in a switch cabinet, the mains voltage should be supplied and turned on via a central power distributor.

### Grounding

On the rear of the unit, there is a screw which can be used to connect the unit to ground, e.g. using the grounding of the pumping station.

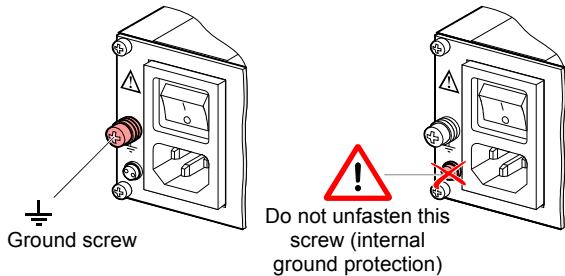

### 3.4 SENSOR Connector

The AGC-100 is equipped with two different gauge connectors.

 **Caution**



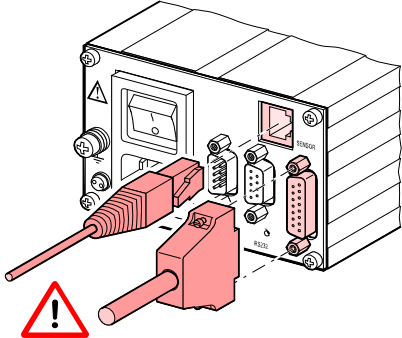

Caution: one channel measurement unit  
Connecting more than one gauge at the same time may lead to gauge destruction.



1 only at once

Make sure that there is never more than one gauge connected to the AGC-100 at the same time.

Connect the gauge to one of the two SENSOR connectors on the rear of the unit. Use a screened 1:1 cable (electromagnetic compatibility). Make sure the gauge is compatible (→  9).

 **DANGER**



**DANGER: protective low voltage**  
According to EN 61010, voltages exceeding 30 VAC or 60 VDC are hazardous.

If you are using the AGC-100 as desk-top unit, you may only connect a protective low voltage (SELV).

Pin assignment  
SENSOR

Pin assignment of  
the 8-pin RJ45  
appliance connector:

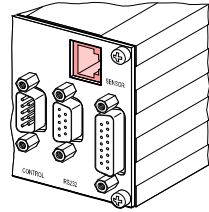

Pin	Signal
4	Identification
1	Supply +24 VDC
2	Supply common GND
3	Signal input (Measurement signal+)
5	Signal common (Measurement signal-)
6	Status
7	HV_L
8	HV_H

Pin assignment of  
the female 15-pin  
D-Sub appliance  
connector:

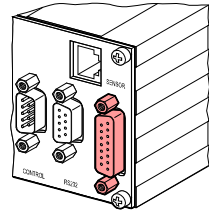
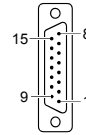

Pin	Signal
10	Identification
8	Supply for Hot Cathode Gauges
11	Supply for Capacitance Diaphragm Gauges
5	Supply common GND
2	Signal input (Measurement signal+)
12	Signal common (Measurement signal-)
3	Status
1	Emission status
7	Degas
4	HV_H
13	RXD
14	TXD
15	Screening = chassis
6, 9	not connected

**3.5 CONTROL  
Connector**

This connector allows to read the measurement signal, to evaluate state of the floating switching function and error contacts.



Connect the peripheral components to the CONTROL connector on the rear of the unit. Use a shielded cable (electromagnetic compatibility).

STOP
DANGER







**DANGER: protective low voltage**  
According to EN 61010, voltages exceeding 30 VAC or 60 VDC are hazardous.

If you are using the AGC-100 as desk-top unit, you may only connect a protective low voltage (SELV).

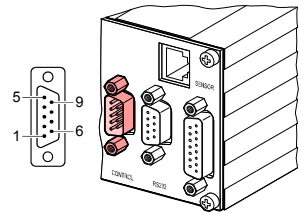
Pin assignment  
Contact positions  
CONTROL

Pin assignment of the male 9-pin D-Sub appliance connector:



Pin	Signal	
1	Analog output 0 ... +10 VDC	
7	Chassis = GND	
5	HV_H on +24 V off 0 V	
	The control over this signal is placed superior to the key operation.	
4	 Pressure below threshold	 Pressure above threshold or power supply turned off
3		
2		
	Error signal	
9	 No error	 Error or power supply turned off
8		
	Supply for relays with higher switching power	
6	+24 VDC, 200 mA Chassis = GND	Fuse-protected at 300 mA with PTC element, self-resetting after power off or pulling the CONTROL connector. Meets the requirements of a grounded protective extra low voltage (SELV).
7		

### 3.6 RS232 Interface Connector

The RS232C interface allows for operating the AGC-100 via a HOST or terminal. It can also be used for updating the firmware (→  76).



Connect the serial interface to the RS232 connector on the rear of the unit using your own, screened (electromagnetic compatibility) cable.



**DANGER**



**DANGER: protective low voltage**  
According to EN 61010, voltages exceeding 30 VAC or 60 VDC are hazardous.

If you are using the AGC-100 as desk-top unit, you may only connect a protective low voltage (SELV).

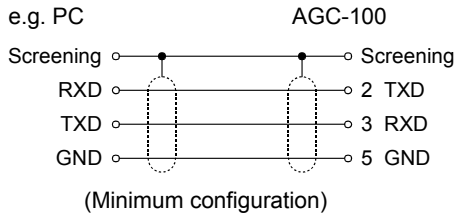

#### Pin assignment RS232

Pin assignment of the female 9-pin D-Sub appliance connector:

Pin	Signal
2	TXD
3	RXD
5	GND
6	DSR
8	CTS
9	GND

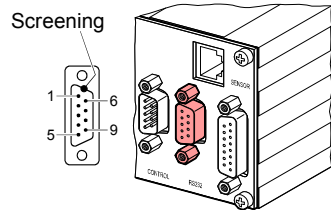

Pin	Signal
1	not connected
4	not connected
7	not connected

Chassis = screening



## 4 Operation

### 4.1 Front Panel

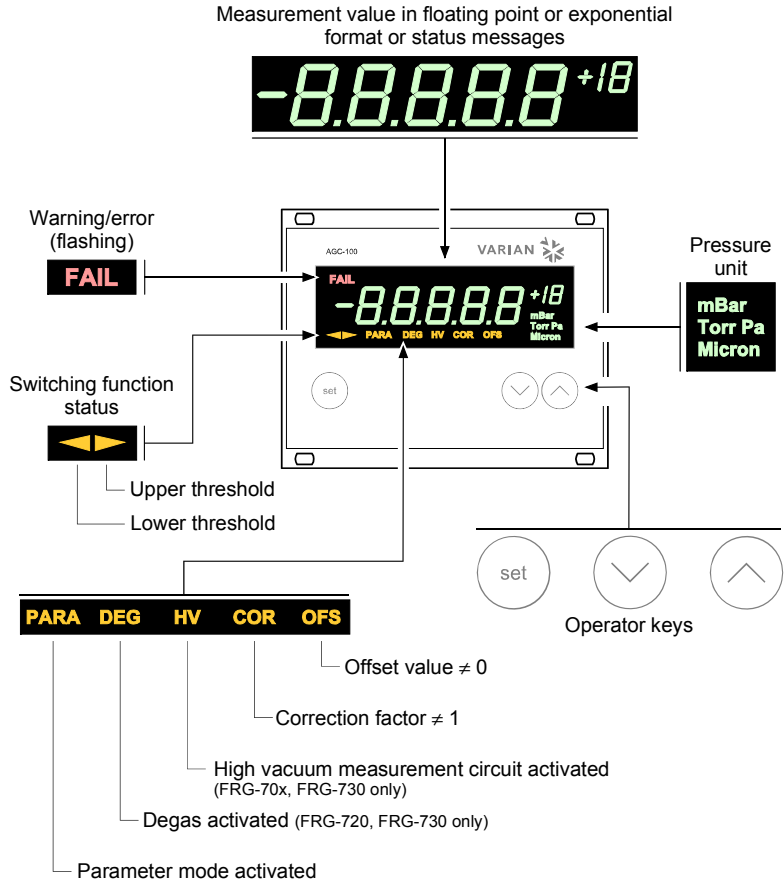

## 4.2 Turning the AGC-100 On and Off

Make sure the AGC-100 is correctly installed and the specifications in the Technical Data are met.

Turning the AGC-100 on

The power switch is on the rear of the unit.

Turn the AGC-100 on with the power switch (or centrally, via a switched power distributor, if the unit is incorporated in a rack).

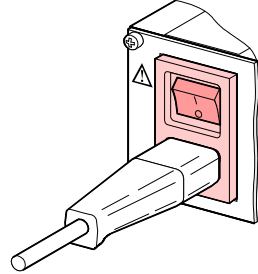

After power on, the AGC-100 ...

- automatically performs a self-test
- identifies the connected gauge
- activates the parameters that were in effect before the last power off
- switches to the Measurement mode
- adapts the parameters if required (if another gauge was previously connected).

Turning the AGC-100 off

Turn the AGC-100 off with the power switch (or centrally, via a switched power distributor, if the unit is incorporated in a rack).



Wait at least 10 s before turning the AGC-100 on again in order for it to correctly initialize itself.

## 4.3 Operating Modes

The AGC-100 works in the following operating modes:

- Measurement mode  
for displaying measurement values or status messages (→ [27](#))
- Parameter mode  
for entering or displaying parameters (→ [29](#))
- Test mode  
for running internal test programs (→ [41](#))
- Program transfer mode  
for updating the firmware (→ [76](#))

### 4.4 Measurement Mode

The Measurement mode is the standard operating mode of the AGC-100. Measurement values and status messages as well as the gauge identification are displayed in this mode.

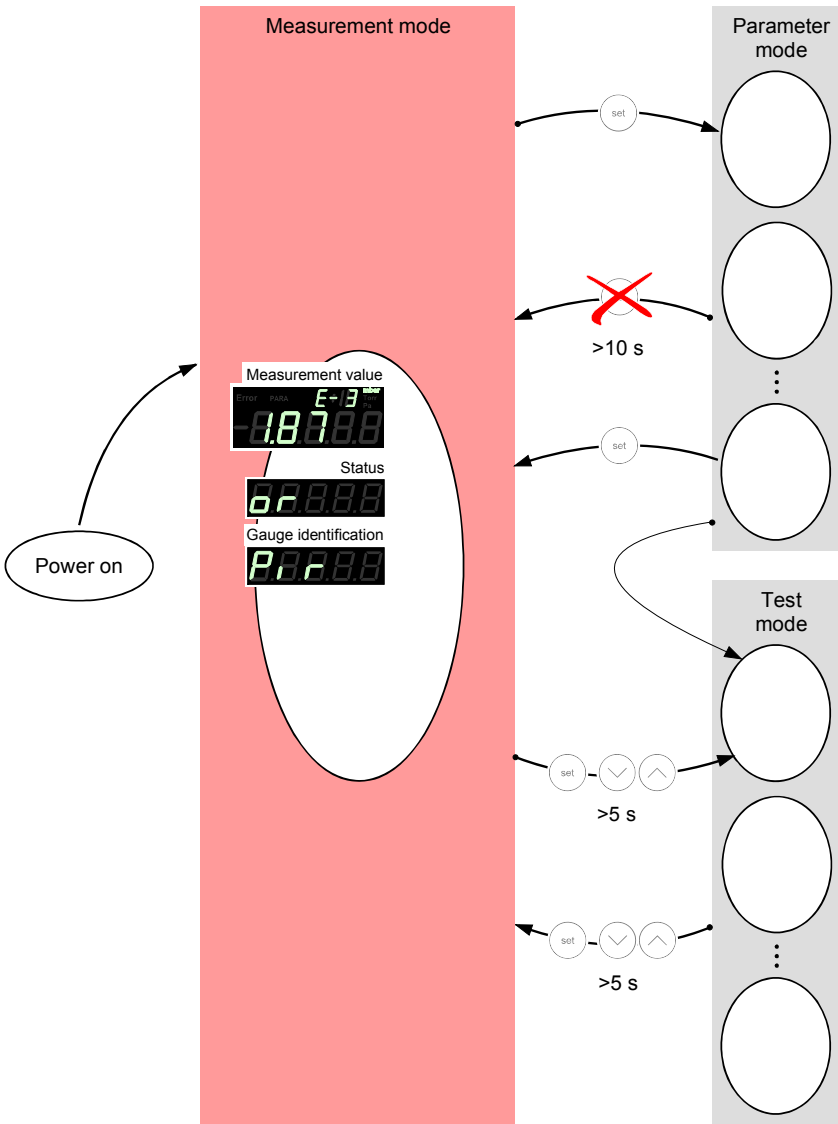

Displaying the gauge identification

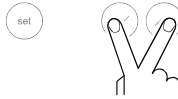

⇒ Press keys >0.5 s:  
The type of the connected gauge is automatically identified and displayed for 5 s:

Pirani gauge (PVG-500, PVG-502)	
Pirani/Capacitive gauge (PCG-750, PCG-752)	
Cold cathode/Pirani gauge (FRG-700, FRG-702)	
Hot cathode/Pirani gauge (FRG-720)	
Hot cathode/Pirani gauge (FRG-730)	
Linear gauge (capacitive, digital) (CDG-500)	
No gauge connected (no Sensor)	
Connected gauge cannot be identified (no Identifier)	

Getting to the Parameter mode

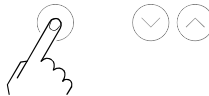

→  29

Getting to the Test mode

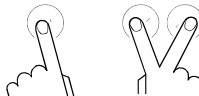

Press keys >5 s  
(→  41)

### 4.5 Parameter Mode

The Parameter mode is used for displaying, editing and entering parameter values.

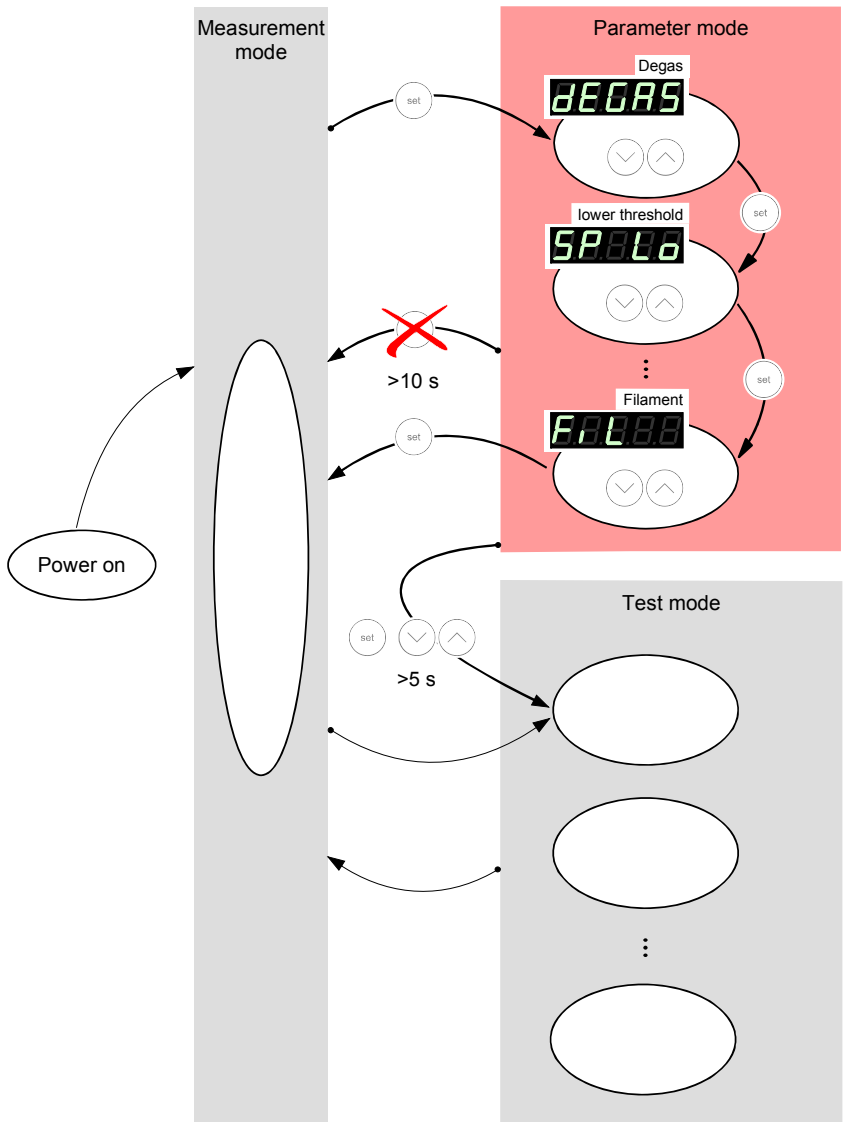

### Selecting a parameter



⇒ The name of the parameter

e.g.: **DEGAS**

Degas

is displayed as long as the key is pressed or at least for 2 s.

Afterwards, the currently valid parameter value is displayed.

Some parameters are not available for all gauge types. They are only displayed if available.

→  31 32 35 35 36 37 38 39 39 40 40

Available for	DEGAS	SP.HI	FS	oFS	UNIT	Cor	FILT	977	979	6A	EN	FIL
P.P	-	✓	-	-	✓	✓	✓	✓	✓	✓	-	-
PCG	-	✓	-	-	✓	✓	✓	✓	✓	✓	-	-
F.P010	-	✓	-	-	✓	✓	✓	✓	✓	✓	-	-
F.P012	✓	✓	-	-	✓	✓	-	✓	✓	✓	-	-
F.P013	✓	✓	-	-	✓	✓	-	✓	✓	✓	✓	✓
LDG	-	✓	✓	✓	✓	-	✓	-	✓	-	-	-

### Editing the parameter value



⇒ Press key <1 s:  
The value is increased/  
decreased by 1 increment.

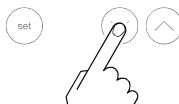

Press key >1 s:  
The value is increased/  
decreased continuously.

Modifications of parameters come into effect immediately and are stored automatically. Exceptions are mentioned under the corresponding parameters.

Loading the default parameters



⇒ Press keys >5 s:  
All user-defined parameters are restored to their default values (→  75).



Loading of the default parameter settings is irreversible.

Getting to the Test mode



Press keys >5 s  
(→  41)

## 4.5.1 Parameters

Degas





Contamination deposits on the electrode system of Hot cathode gauges may cause instabilities of the measurement values. The Degas function allows to clean the electrode system.



FRG-730 gauges: The Degas function acts only upon the active filament.

Available for:

- Pirani (PVG)
- Pirani/Capacitive (PCG)
- Cold cathode/Pirani (FRG-70x)
- Hot cathode/Pirani (FRG-720, FRG-730)
- Capacitive (CDG)



	Value
	<div style="text-align: right;"><b>DEG</b></div>
	<p>⇒ Normal operation.</p> 
	<p>⇒ Degas: The electron collection grid is heated to <math>\approx 700\text{ }^{\circ}\text{C}</math> by electron bombardment and the electrode system is thus cleaned.</p> 
	<p>Duration of the Degas function: 3 min (can be aborted).</p>



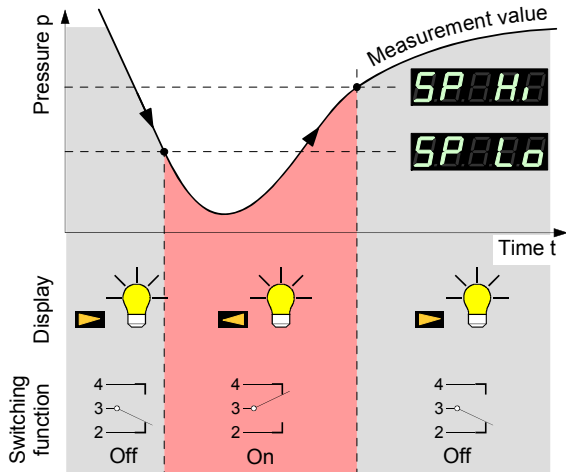





Lower/upper switching threshold

The AGC-100 has a switching function with two adjustable thresholds. The status of the switching function is displayed on the front panel (→ [25](#)) and can be evaluated via the floating contact at the CONTROL connector (→ [22](#)).







	Value
	The lower switching threshold (Setpoint low) defines the pressure at which the switching function is activated when the pressure is dropping.
e.g.: 	⇒ gauge dependent (→ table). If another gauge type is connected, the AGC-100 automatically adjusts the switching threshold if required.









	lower threshold limit 	upper threshold limit 
	$2 \times 10^{-3}$	$5 \times 10^2$
	$2 \times 10^{-3}$	$1.5 \times 10^3$
	$5 \times 10^{-9}$	$1 \times 10^3$
	$1 \times 10^{-8}$	$1 \times 10^3$
	$1 \times 10^{-8}$	$1 \times 10^3$
	FSr / 1000	FSr

all values in mbar, Cor = 1



The minimum hysteresis between the upper and lower switching threshold is at least 10% of the lower threshold or 1% of the set full scale value. If the value of the minimum hysteresis drops below these values, the upper threshold is automatically adjusted. This prevents unstable states.

	Value
 e.g.: 	<p>The upper switching threshold (Setpoint high) defines the pressure at which the switching function is deactivated when the pressure is rising.</p> <p>⇒ gauge dependent (→ table).</p> <p>If another gauge type is connected, the AGC-100 automatically adjusts the threshold if required.</p>

	lower threshold limit 	upper threshold limit 
	+10% lower threshold	$5 \times 10^2$
	+10% lower threshold	$1.5 \times 10^3$
	+10% lower threshold	$1 \times 10^3$
	+10% lower threshold	$1 \times 10^3$
	+10% lower threshold	$1 \times 10^3$
	+1% measurement range (FSr)	FSr

all values in mbar, Cor = 1





The minimum hysteresis between the upper and lower switching threshold is at least 10% of the lower threshold or 1% of the set full scale value. This prevents unstable states.

Measurement range of capacitive gauges

The full scale value of the measurement range (**Full Scale range**) of the linear gauges has to be defined by the user; the full scale value of logarithmic gauges is automatically recognized.

Available for:

- Pirani (PVG)
- Pirani/Capacitive (PCG)
- Cold cathode/Pirani (FRG-70x)
- Hot cathode/Pirani (FRG-720, FRG-730)
- Capacitive (CDG)

	Value
	
e.g.: 	⇒ 0.01 mbar 0.01 Torr, 0.02 Torr, 0.05 Torr 0.10 mbar 0.10 Torr, 0.25 Torr, 0.50 Torr 1 mbar 1 Torr, 2 Torr 10 mbar 10 Torr 100 mbar 100 Torr 1000 mbar, 1100 mbar 1000 Torr 2 bar, 5 bar, 10 bar, 50 bar

Conversion table → Appendix,  74

Offset correction

The offset value is displayed, zero adjustment of the gauge and adjustment to the currently measured value (in the range -5 ... +110% of the full scale setting).









First adjust the gauge and then the controller.



Available for:



- Pirani (PVG)
- Pirani/Capacitive (PCG)
- Cold cathode/Pirani (FRG-70x)
- Hot cathode/Pirani (FRG-720, FRG-730)
- Capacitive (CDG)



The offset correction affects:

- the displayed measurement value
- the displayed threshold value of the switching functions
- the analog output at the CONTROL connector  
(→  22)

	Value
	
	⇒ Offset correction deactivated 
e.g.: 	⇒ Offset correction activated 

  ⇒ Press key >2 s:  
The offset value is readjusted. The actual measurement value is accepted as new offset value.

  ⇒ Reset the offset value.

  ⇒ Press >2 s  
Zero adjustment of the gauge.











When the offset correction is activated, the stored offset value is subtracted from the actual measurement value. This allows measuring relative to a reference pressure.



When the zero of the gauge is readjusted, the offset correction must be deactivated.

Pressure unit



Unit of measured values, thresholds etc.. See Appendix (→  74) for conversion.

	Value	
		
	⇒ mbar/bar	
	⇒ Torr (only available if Torr lock is not activated i.e. Torr is not suppressed → 44)	
	⇒ Pascal	
	⇒ Micron (=mTorr)	

A change of the pressure unit influences also the settings of the FRG-720 and FRG-730 gauges.







When selecting Micron, above 99000 Micron the readout automatically changes over to Torr. When the pressure drops below 90 Torr the instrument automatically switches back to Micron.

### Correction factor

The correction factor allows the measured value to be calibrated for other gases than N<sub>2</sub> (→   [1] ... [5]).

Available for:

		Only for pressures
<input checked="" type="checkbox"/> Pirani	(PVG)	
<input checked="" type="checkbox"/> Pirani/Capacitive	(PCG)	<10 mbar
<input checked="" type="checkbox"/> Cold cathode/Pirani	(FRG-70x)	<1×10 <sup>-2</sup> mbar
<input checked="" type="checkbox"/> Hot cathode/Pirani	(FRG-720, FRG-730)	<1×10 <sup>-2</sup> mbar
<input type="checkbox"/> Capacitive	(CDG)	

	Value	
		
e.g.: 	⇒ No correction	
e.g.: 	⇒ Measurement value corrected by a factor of 0.10 ... 10.00	

Measurement value filter

The measurement value filter permits a better evaluation of unstable or disturbed measuring signals.

The filter affects:

- the displayed measurement value
- the analog output
- the digitally transmitted measurement value of hot cathode gauges FRG-720 and FRG-730

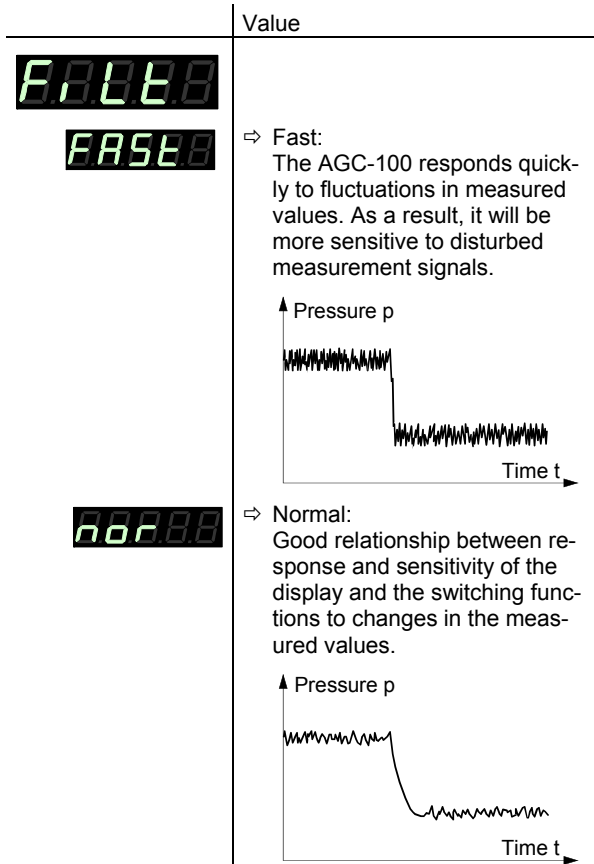



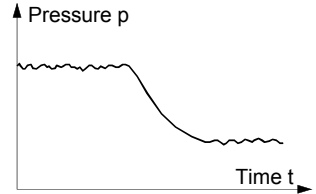

50.000

⇒ Slow:  
The AGC-100 does not respond to small changes in measured values. As a result, it will respond more slowly to changes in the measured values.



Display resolution (digits)

Display resolution of measured values.

	Value
<p>0.0000</p> <p>2.0000</p> <p>3.0000</p>	<p>⇒ Display</p> <ul style="list-style-type: none"> <li>• rounded to one decimal digit </li> <li>• or two integrals </li> </ul> <p>⇒ Display</p> <ul style="list-style-type: none"> <li>• rounded to two decimal digits </li> <li>• or three integrals </li> </ul>

Transmission rate

Transmission rate of the RS232C interface.



	Value
<p>6A000</p> <p>e.g.: 96000</p>	<p>⇒ 9600 baud</p> <p>19200 baud</p> <p>38400 baud</p>

Emission

Switching the emission on and off.

Available for:

- Pirani (PVG)
- Pirani/Capacitive (PCG)
- Cold cathode/Pirani (FRG-70x)
- Hot cathode/Pirani (FRG-730 only)
- Capacitive (CDG)





	Value
	
	⇒ the emission is switched on and off automatically by the gauge
	⇒ the emission is switched on and off by the user

Filament

Means of selection.

Available for:

- Pirani (PVG)
- Pirani/Capacitive (PCG)
- Cold cathode/Pirani (FRG-70x)
- Hot cathode/Pirani (FRG-730 only)
- Capacitive (CDG)

	Value
	
	⇒ the gauge automatically alternates between the filaments
	⇒ filament 1 active
	⇒ filament 2 active



## 4.6 Test Mode

The Test mode is used for displaying, editing and entering special parameter values for testing the AGC-100.

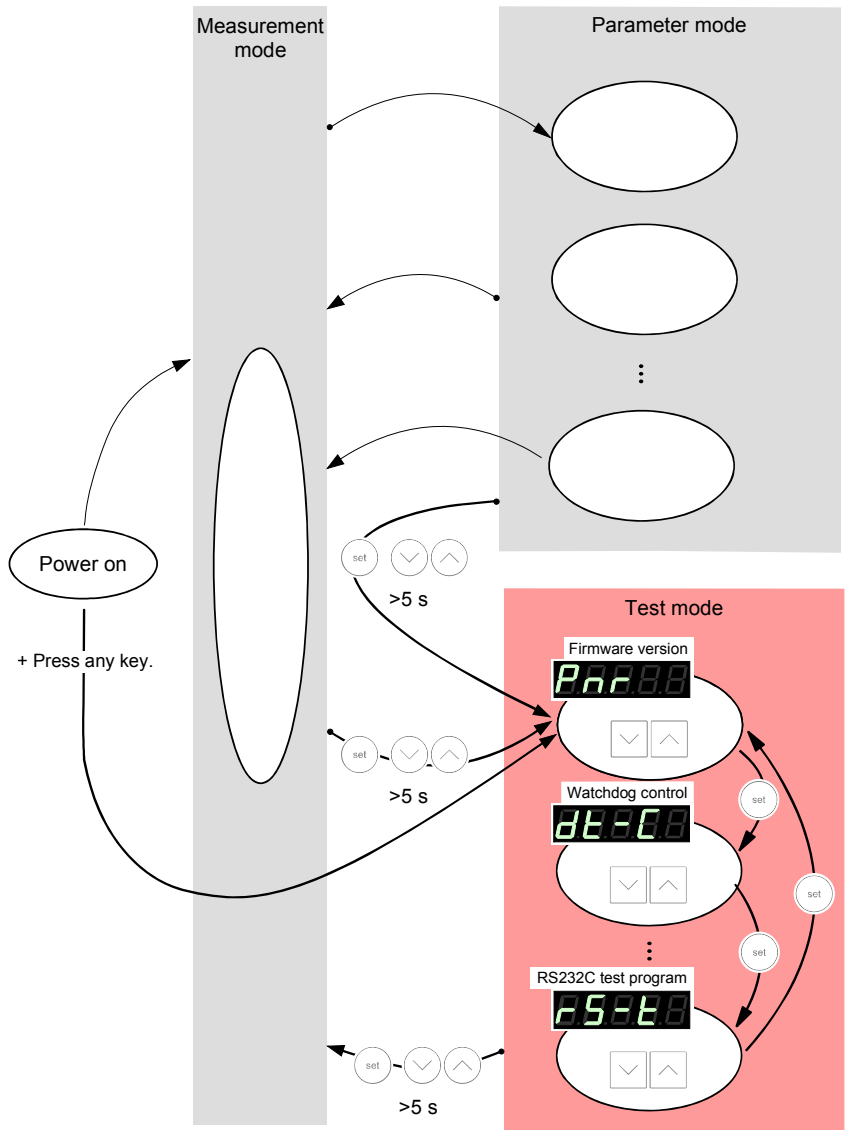

Selecting a parameter



⇒ The name of the parameter  
e.g.:   
Firmware version  
is displayed.

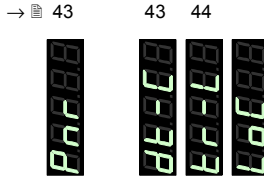

The name of the parameter is displayed as long as the key is pressed or at least for 2 s.

The firmware version is continuously displayed.

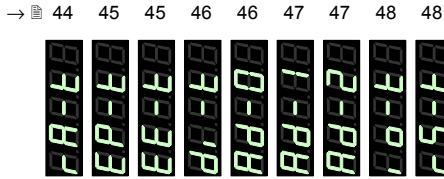

The name of the test program is displayed until it is started.

Modifying a parameter



⇒ Increase/decrease the value by the defined increments.

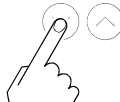



Starting the test program

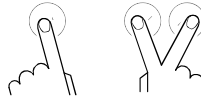

⇒ Start test program.

Changing to the Measurement mode





Press keys >5 s  
 (→  27)  
 or  
 turn the unit off, wait for 10 s  
 and then turn it on again.

### 4.6.1 Parameters

Firmware version



The firmware version (program version) is displayed.

	Version
	⇒ The two parts of the firmware number are displayed alternately.
	
	

The last character indicates the modification index (-, A ... Z). Please mention this index when contacting VARIAN in the event of a fault.



Watchdog control

Behavior of the system control (watchdog) in the event of an error.

	Setting
	⇒ The system automatically acknowledges error messages of the watchdog after 2 s.
	
	



Torr lock

The pressure unit **Torr** can be suppressed in the corresponding parameter setting **UNPEE** (→  36).

	Setting
	
	⇒ Pressure unit <b>Torr</b> available.
	⇒ Pressure unit <b>Torr</b> not available.

Parameter setup lock





This parameter affects the parameter mode. When the lock is activated, the user can inspect but not modify parameter values.

	Setting
	
	⇒ Parameters can be inspected and modified
	⇒ Parameters can be inspected only.

## 4.6.2 Test Programs





RAM test

Test of the main memory.

	Test sequence
	The test runs automatically one time:
	⇒ Test in process (very briefly).
	⇒ Test finished, no error found.
	⇒ Test finished, error(s) found. The <b>FAIL</b> lamp flashes.





EPROM test

Test of the program memory.

	Test sequence
	The test runs automatically one time:
	⇒ Test in process
	⇒ Test finished, no error found. After the test, a four-digit checksum (hexadecimal format) is displayed.
	⇒ Test finished, error(s) found. After the test, a four-digit checksum (hexadecimal format) is displayed. The <b>FAIL</b> lamp flashes.

EEPROM test

Test of the parameter memory.

	Test sequence
	The test runs automatically one time:
	⇒ Test in process (very briefly).
	⇒ Test finished, no error found.
	⇒ Test finished, error(s) found. The <b>FAIL</b> lamp flashes.

Display test

Test of the display.

	Test sequence
	<p>The test runs automatically one time <sup>1)</sup>:</p> <p>⇒ First, all display elements are lit at the same time, ...</p> <p>⇒ ... and then, each element is lit individually.</p>

1)

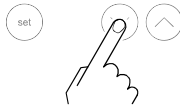

⇒ Stop the test sequence and activate one element after another by pressing the key once per element.

A/D converter test 0

Test of channel 0 of the analog/digital converter (with a reference voltage at the signal input of the SENSOR connector (→ 22)).



The measurement value filter affects the applied voltage. If the signal input is open, the AGC-100 displays a default value that may easily fluctuate because of the high sensitivity of the open measurement circuit.

	Test sequence
	<p>⇒ Positive portion of the measurement signal in Volt</p>

### A/D converter test 1

Test of channel 1 of the analog/digital converter (with a reference voltage at the signal input of the SENSOR connector (→  22)).



The measurement value filter affects the applied voltage. If the signal input is open, the AGC-100 displays a default value that may easily fluctuate because of the high sensitivity of the open measurement circuit.



	Test sequence
	<p>⇒ Negative portion of the measurement signal in Volt.</p>

### A/D converter test 2

Test of channel 2 of the analog/digital converter (with a reference voltage at the signal input of the SENSOR connector (→  22)).



The measurement value filter affects the applied voltage. If the signal input is open, the AGC-100 displays a default value that may easily fluctuate because of the high sensitivity of the open measurement circuit.

	Test sequence
	<p>⇒ Gauge identification voltage</p>
	<p>⇒ No gauge connected</p>

I/O test

Test of the two relays of the AGC-100. The program tests their switching function.









**Caution**



Caution: The relays switch irrespective of the pressure  
Starting a test program may cause unwanted effects in connected control systems.  
Disconnect all sensor cables and control system lines to ensure that no control commands or messages are triggered by mistake.

The relays switch on and off cyclically. The switching operations are indicated optically and can be heard.  
The contacts are connected to the CONTROL connector on the rear of the housing (→  22). Check the switching function with an ohmmeter.

	Test sequence
	The test runs automatically one time:
	⇒ both relays deactivated
	⇒ switching function relay
	⇒ switching function relay
	⇒ error relay
	⇒ error relay

RS232C test

Test of the RS232C interface. The AGC-100 repeats each sign transmitted by the communicating HOST.

 The data transferred from/to the AGC-100 can be displayed by the computer only (→ Section 5).

	Test sequence
	The test runs automatically.



## 5 Communication (Serial Interface)

### 5.1 RS232C Interface

The serial interface is used for communication between the AGC-100 and a computer. A terminal can be connected for test purposes.

When the AGC-100 is put into operation, it starts transmitting measured values in intervals of 1 s. As soon as the first character is transferred to the AGC-100, the automatic transmission of measured values stops. After the necessary inquiries or parameter modifications have been made, the transmission of measured values can be started again with the **COM** command (→  55).

Connection diagram,  
connection cable

Pin assignment of the 9-pin D-Sub connector and RS232C cable →  24.

#### 5.1.1 Data Transmission

The data transmission is bi-directional, i.e. data and control commands can be transmitted in either direction.

Data format

1 start bit  
8 data bits  
No parity bit  
1 stop bit  
No hardware handshake

Definitions

The following abbreviations and symbols are used:

Symbol	Meaning	Dec	Hex
HOST	Computer or terminal		
[...]	Optional elements		
ASCII	American Standard Code for Information Interchange		
<ETX>	END OF TEXT (CTRL C) Reset the interface	3	03
<CR>	CARRIAGE RETURN Go to beginning of the line	13	0D
<LF>	LINE FEED Advance by one line	10	0A
<ENQ>	ENQUIRY Request for data transmission	5	05
<ACK>	ACKNOWLEDGE Positive report signal	6	06
<NAK>	NEGATIVE ACKNOWLEDGE Negative report signal	21	15

"Transmit": Data transfer from HOST to AGC-100

"Receive": Data transfer from AGC-100 to HOST

Format of pressure values

For pressure values, the following format is used:

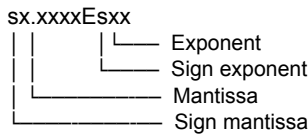

Flow Control

After each ASCII string, the HOST must wait for a report signal (<ACK><CR><LF> or <NAK> <CR><LF>).

The input buffer of the HOST must have a capacity of at least 25 bytes.

### 5.1.2 Communication Protocol

Transmission format

Messages are transmitted to the AGC-100 as ASCII strings in the form of mnemonics and parameters. All mnemonics comprise three ASCII characters.

Spaces are ignored. <ETX> (CTRL C) clears the input buffer in the AGC-100.

The input is terminated by <CR> or <LF> or <CR><LF> ("end of message"), and evaluation in the AGC-100 is subsequently started.

The tables starting on  53 are applicable to the mnemonics and parameters. The maximum number of digits, the data formats and admissible value ranges are also specified there.

Transmission protocol

HOST	AGC-100	Explanation
Mnemonics		
[and parameters]	—————>	Receives message with "end of message"
<CR>[<LF>]	—————>	
<———— <ACK><CR><LF>		Positive acknowledgment of a received message

Reception format

When requested with a mnemonic instruction, the AGC-100 transmits the measurement data or parameters as ASCII strings to the HOST.

<ENQ> must be transmitted to request the transmission of an ASCII string. Additional strings, according to the last selected mnemonic, are read out by repetitive transmission of <ENQ>.

If <ENQ> is received without a valid request, the ERROR word is transmitted.

Reception protocol	HOST	AGC-100	Explanation
	Mnemonics [and parameters] —————>		Receives message with "end of message"
	<CR>[<LF>] —————>		
	<———— <ACK><CR><LF>		Positive acknowledgment of a received message
	<ENQ> —————>		Requests to transmit
	<———— Measurement values or parameters		
	<———— <CR><LF>		Transmits data with "end of message"
	:	:	
	<ENQ> —————>		Requests to transmit
	<———— Measurement values or parameters		
	<———— <CR><LF>		Transmits data with "end of message"

**Error processing** All strings received are verified in the AGC-100. If an error is detected, a negative acknowledgment <NAK> is output. The appropriate flag is set in the ERROR word. Errors can be decoded when the ERROR word is read.

Error recognition protocol	HOST	AGC-100	Explanation
	Mnemonics [and parameters] —————>		Receives message with "end of message"
	<CR>[<LF>] —————>		
	***** Transmission or programming error *****		
	<———— <NAK><CR><LF>		Negative acknowledgment of a received message
	Mnemonics [and parameters] —————>		Receives message with "end of message"
	<CR>[<LF>] —————>		
	<———— <ACK><CR><LF>		Positive acknowledgment of a received message

## 5.2 Mnemonics



<b>BAU</b>	Baud rate	62
<b>COM</b>	Continuous mode	55
<b>COR</b>	Correction factor	61
<b>DCD</b>	Display control digits	61
<b>DGS</b>	FRG-720, FRG-730 degas on/off	57
<b>ERR</b>	Error status	56
<b>EUM</b>	FRG-730 emission user mode	62
<b>FIL</b>	Filter time constant	61
<b>FSR</b>	CDG full scale range	59
<b>FUM</b>	FRG-730 filament user mode	62
<b>HVC</b>	HV, EMI on/off	55
<b>ITR</b>	FRG-720, FRG-730, CDG data output	56
<b>LOC</b>	Parameter setup lock	64
<b>OFS</b>	Offset correction	60
<b>PNR</b>	Program number	63
<b>PR1</b>	Pressure measurement	54
<b>RES</b>	Reset	57
<b>SAV</b>	Save parameters to EEPROM	62
<b>SP1</b>	Setpoint	58
<b>SPS</b>	Setpoint status	58
<b>TAD</b>	A/D converter test	66
<b>TDI</b>	Display test	65
<b>TEE</b>	EEPROM test	65
<b>TEP</b>	EPROM test	65
<b>TID</b>	Sensor identification	56
<b>TIO</b>	I/O test	66
<b>TKB</b>	Keyboard test	67
<b>TLC</b>	Torr lock	64
<b>TRA</b>	RAM test	65
<b>TRS</b>	RS232 test	67
<b>UNI</b>	Pressure unit	60
<b>WDT</b>	Watchdog control	64



Continuous output of measured values (RS232)

Transmit: **COM** [,x] <CR>[<LF>]  
 |  
 | Mode x = 0 → 100 ms  
 | 1 → 1 s (default)  
 | 2 → 1 min.

Receive: <ACK><CR><LF>  
 <ACK> is immediately followed by the continuous output of the measured value in the desired interval.

Receive: x,sx.xxxxEsxx y <CR><LF>  
 |  
 | | | | |  
 | | | | | Measured value <sup>1)</sup>  
 | | | | | with pressure unit

| Status, x =  
 | 0 → Measurement data okay  
 | 1 → Underrange  
 | 2 → Overrange  
 | 3 → Sensor error  
 | 4 → Sensor off  
 | 5 → No sensor  
 | 6 → Identification error  
 | 7 → Error FRG-720, FRG-730



<sup>1)</sup> The 3<sup>rd</sup> and 4<sup>th</sup> decimal are always 0, except for the CDG gauge.

Activating/deactivating the HV circuit and EMI

Transmit: **HVC** [,x] <CR>[<LF>]  
 |  
 | Mode x = 0 → off (default)  
 | 1 → on

Receive: <ACK><CR><LF>  
 Transmit: <ENQ>

Receive: x <CR><LF>  
 |  
 | Mode

Data output FRG-720,  
FRG-730, CDG

Transmit: **ITR** <CR>[<LF>]  
 Receive: <ACK><CR><LF>  
 Transmit: <ENQ>  
 Receive: xx,xx,xx,xx,xx,xx,xx,xx <CR><LF>

└─ Transmission string byte  
 0 ... 7 in hex format  
 (→  FRG-720, FRG-730,  
 CDG)

Gauge identification

Transmit: **TID** <CR>[<LF>]  
 Receive: <ACK><CR><LF>  
 Transmit: <ENQ>  
 Receive: x <CR><LF>

└─ Identification, x =  
 PVG5xx (Pirani)  
 PCG75x (Pirani/Capacitive)  
 FRG70x (Cold cathode/Pirani)  
 CDG500 (Capacitive)  
 FRG720 (Hot cathode/Pirani)  
 FRG730 (Hot cathode/Pirani)  
 noSEn (no Sensor)  
 nold (no identification)

Error status

Transmit: **ERR** <CR>[<LF>]  
 Receive: <ACK><CR><LF>  
 Transmit: <ENQ>  
 Receive: xxxx <CR><LF>

└─ x =  
 0000 → No error  
 1000 → Controller error  
 (See display on front panel)  
 0100 → NO, HWR No hardware  
 0010 → PAR, Inadmissible parameter  
 0001 → SYN, Syntax error



The ERROR word is cancelled when read out. If the error persists, it is immediately set again.



Reset

Transmit: **RES** [,x] <CR>[<LF>]  
 |  
 └ x = 1 → Reset

Receive: <ACK><CR><LF>

Transmit: <ENQ>

Receive: [x]x,[x]x,... <CR><LF>

- |  
 └ List of all present error messages  
 xx =  
 0 → No error  
 1 → Watchdog has responded  
 2 → Task fail error  
 5 → EPROM error  
 6 → RAM error  
 7 → EEPROM error  
 9 → DISPLAY error  
 10 → A/D converter error  
 11 → Sensor error (e.g. filament  
 rupture, no supply)  
 12 → Sensor identification error

## 5.2.2 Parameter Mode

Degas

Transmit: **DGS** [,x] <CR>[<LF>]  
 |  
 └ x = 0 → off (default)  
 1 → on (3 min.)

Receive: <ACK><CR><LF>

Transmit: <ENQ>

Receive: x <CR><LF>

- |  
 └ Degas status

Threshold value setting, allocation

Transmit: **SP1** [,x.xxEsx,x.xxEsx] <CR>[<LF>]

└─ Upper threshold <sup>1)</sup>  
[in current pressure unit]  
(default = depending on gauge)

└─ Lower threshold <sup>1)</sup>  
[in current pressure unit]  
(default = depending on gauge)

<sup>1)</sup> Values can be entered in any format. They are internally converted into the floating point format.

Receive: <ACK><CR><LF>  
Transmit: <ENQ>

Receive: x.xxxxEsxx,x.xxxxEsxx <CR><LF>

└─ Upper threshold  
[in current pressure unit]

└─ Lower threshold  
[in current pressure unit]

Switching function status

Transmit: **SPS** <CR>[<LF>]  
Receive: <ACK><CR><LF>  
Transmit: <ENQ>

Receive: x <CR><LF>

└─ Switching function x = 0 → off  
1 → on

Measurement range (F.S.) of capacitive gauges



The full scale value of the measurement range (Full Scale) of linear gauges has to be defined by the user; the full scale value of logarithmic gauges is automatically recognized.

Transmit: **FSR** [,x] <CR><LF>

└─ Measurement range, x =

- 0 → 0.01 mbar
- 1 → 0.01 Torr
- 2 → 0.02 Torr
- 3 → 0.05 Torr
- 4 → 0.10 mbar
- 5 → 0.10 Torr
- 6 → 0.25 Torr
- 7 → 0.50 Torr
- 8 → 1 mbar
- 9 → 1 Torr
- 10 → 2 Torr
- 11 → 10 mbar
- 12 → 10 Torr
- 13 → 100 mbar
- 14 → 100 Torr
- 15 → 1000 mbar
- 16 → 1100 mbar
- 17 → 1000 Torr
- 18 → 2 bar
- 19 → 5 bar
- 20 → 10 bar
- 21 → 50 bar

Receive: <ACK><CR><LF>

Transmit: <ENQ>

Receive: x <CR><LF>

└─ Measurement range (F.S.)

Offset correction

Transmit: **OFS** [,x,x.xxxEsx] <CR>[<LF>]

- └─ Offset <sup>1)</sup>  
[in current pressure unit]  
(default = 0.000E0)
- └─ Mode, x =
  - 0 → Off (default)  
No offset value needs to be entered.
  - 1 → On  
If no offset value has been entered, the previously defined offset value is taken over.
  - 2 → Auto (offset measurement)  
No offset value needs to be entered.

<sup>1)</sup> Values can be entered in any format. They are internally converted into the floating point format.

Receive: <ACK><CR><LF>

Transmit: <ENQ>

Receive: x,sx.xxxxEsxx <CR><LF>

- └─ Offset  
[in current pressure unit]
- └─ Mode

Measurement unit

Transmit: **UNI** [,x] <CR>[<LF>]

- └─ x = 0 → mbar/bar (default)
- 1 → Torr
- 2 → Pascal
- 3 → Micron

Receive: <ACK><CR><LF>

Transmit: <ENQ>

Receive: x <CR><LF>

- └─ Measurement unit

Correction factor      Transmit:      **COR** [,][x].xxx] <CR>[<LF>]

└─ 0.100 ... 10.000  
(default = 1.000)

Receive:      <ACK><CR><LF>

Transmit:      <ENQ>

Receive:      [x].xxx <CR><LF>

└─ Correction factor

Number of digits in the display      Transmit:      **DCD** [,x] <CR>[<LF>]

└─ x = 2 → 2 digits (default)  
3 → 3 digits

Receive:      <ACK><CR><LF>

Transmit:      <ENQ>

Receive:      x <CR><LF>

└─ Number of digits

Measurement value filter      Transmit:      **FIL** [,x] <CR>[<LF>]

└─ x = 0 → fast  
1 → medium (default)  
2 → slow

Receive:      <ACK><CR><LF>

Transmit:      <ENQ>

Receive:      x <CR><LF>

└─ Filter time constant

Transmission rate      Transmit:      **BAU** [,x] <CR>[<LF>]

└─ x = 0 → 9600 baud (default)  
                   1 → 19200 baud  
                   2 → 38400 baud



As soon as the new baud rate has been entered, the report signal is transmitted at the new transmission rate.

Receive:      <ACK><CR><LF>  
 Transmit:     <ENQ>

Receive:      x <CR><LF>  
                   └─ Transmission rate

Emission                Transmit:      **EUM** [,x] <CR>[<LF>]

└─ x = 0 → Manually  
                   1 → Automatically (default)

Receive:      <ACK><CR><LF>  
 Transmit:     <ENQ>

Receive:      x <CR><LF>

Filament                Transmit:      **FUM** [,x] <CR>[<LF>]

└─ x = 0 → Automatically (default)  
                   1 → Filament 1  
                   2 → Filament 2

Receive:      <ACK><CR><LF>  
 Transmit:     <ENQ>

Receive:      x <CR><LF>

Save parameters to EEPROM      Transmit:      **SAV** [,x] <CR>[<LF>]

└─ x = 0 → Save default parameters  
                   1 → Save user parameters

Receive:      <ACK><CR><LF>

### 5.2.3 Test Mode

(For service specialists)

Firmware version

Transmit: **PNR** <CR>[<LF>]

Receive: <ACK><CR><LF>

Transmit: <ENQ>

Receive: xxx-xxx-x <CR><LF>

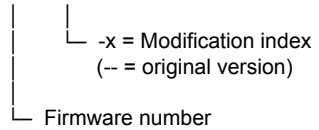

Watchdog control

Transmit: **WDT** [,x] <CR>[<LF>]  
 |  
 └ x = 0 → Manual error acknowledgement  
 1 → Automatic error acknowledgement <sup>1)</sup> (default)



<sup>1)</sup> If the watchdog has responded, the error is automatically acknowledged and cancelled after 2 s.

Receive: <ACK><CR><LF>  
 Transmit: <ENQ>  
 Receive: x <CR><LF>  
 |  
 └ Watchdog control

Torr lock

Transmit: **TLC** [,x] <CR>[<LF>]  
 |  
 └ x = 0 → off (default)  
 1 → on  
 Receive: <ACK><CR><LF>  
 Transmit: <ENQ>  
 Receive: x <CR><LF>  
 |  
 └ Torr lock status

Parameter setup lock

Transmit: **LOC** [,x] <CR>[<LF>]  
 |  
 └ x = 0 → off (default)  
 1 → on  
 Receive: <ACK><CR><LF>  
 Transmit: <ENQ>  
 Receive: x <CR><LF>  
 |  
 └ Parameter setup lock status



RAM test

Transmit: **TRA** <CR>[<LF>]  
 Receive: <ACK><CR><LF>  
 Transmit: <ENQ> Starts the test (duration <1 s)  
 Receive: xxxx <CR><LF>  
           |  
           └─ ERROR word

EPROM test

Transmit: **TEP** <CR>[<LF>]  
 Receive: <ACK><CR><LF>  
 Transmit: <ENQ> Starts the test (duration ≈10 s)  
 Receive: xxxx,xxxx <CR><LF>  
           |          |  
           └─ Check sum (hex)  
           |  
           └─ ERROR word

EEPROM test

Transmit: **TEE** <CR>[<LF>]  
 Receive: <ACK><CR><LF>  
 Transmit: <ENQ> Starts the test (duration <1 s)

 Do not keep repeating the test (EEPROM life).

Receive: xxxx <CR><LF>  
           |  
           └─ ERROR word

Display test

Transmit: **TDI** [,x] <CR>[<LF>]  
           |  
           └─ x = 0 → Stops the test – display according to current operating mode (default)  
                   1 → Starts the test – all LEDs on

Receive: <ACK><CR><LF>  
 Transmit: <ENQ>  
 Receive: x <CR><LF>  
           |  
           └─ Display test status

ADC test

Transmit: **TAD** <CR>[<LF>]  
 Receive: <ACK><CR><LF>  
 Transmit: <ENQ>  
 Receive: [x]x.xxxx, x.xxxx, x.xxxx <CR><LF>

└─ ADC channel 2  
 Gauge  
 identification  
 [0.0000 ...  
 5.0000 V]

└─ ADC channel 1  
 Measurement signal  
 (negative portion)  
 [0.0000 ... 5.0000 V]

└─ ADC channel 0  
 Measurement signal (positive  
 portion) [0.0000 ... 11.0000 V]

I/O test

Transmit: **TIO** [,x] <CR>[<LF>]

└─ x =  
 0 → Stops the test (default)  
 1 → Setpoint relay off,  
 error relay off  
 2 → Setpoint relay on,  
 error relay off  
 3 → Setpoint relay off,  
 error relay on  
 4 → Setpoint relay on,  
 error relay on

Receive: <ACK><CR><LF>  
 Transmit: <ENQ>  
 Receive: x <CR><LF>

└─ I/O test status

Operator key test

Transmit: **TKB** <CR>[<LF>]

Receive: <ACK><CR><LF>

Transmit: <ENQ>

Receive: xxx <CR><LF>

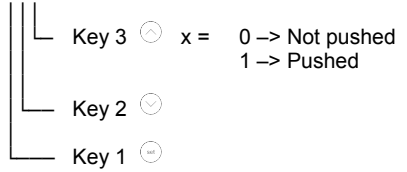

RS232 test

Transmit: **TRS** <CR>[<LF>]

Receive: <ACK><CR><LF>

Transmit: <ENQ> Starts the test (repeats each character, test is interrupted with <CTRL> C).

## 5.2.4 Example



"Transmit (T)" and "Receive (R)" are related to the host.

T: <b>TID</b> <CR> [<LF>]	Request for gauge identification
R: <ACK> <CR> <LF>	Positive acknowledgement
T: <ENQ>	Request for data transmission
R: PVG5xx <CR> <LF>	Gauge identification
T: <b>SP1</b> <CR> [<LF>]	Request for parameters of switching function (setpoint)
R: <ACK> <CR> <LF>	Positive acknowledgement
T: <ENQ>	Request for data transmission
R: 1.0000E-09,9.0000E-07 <CR> <LF>	Thresholds
T: <b>SP1</b> ,6.80E-3,9.80E-3 <CR> [<LF>]	Modification of threshold values of switching function (setpoint)
R: <ACK> <CR> <LF>	Positive acknowledgement
T: <b>FOL</b> ,2 <CR> [<LF>]	Modification of filter time constant (syntax error)
R: <NAK> <CR> <LF>	Negative acknowledgement
T: <ENQ>	Request for data transmission
R: 0001 <CR> <LF>	ERROR word
T: <b>FIL</b> ,2 <CR> [<LF>]	Modification of filter time constant
R: <ACK> <CR> <LF>	Positive acknowledgement
T: <ENQ>	Request for data transmission
R: 2 <CR> <LF>	Filter time constant
T: <b>PR1</b> <CR> [<LF>]	Request for measurement data
R: <ACK> <CR> <LF>	Positive acknowledgement
T: <ENQ>	Request for data transmission
R: 0,8.3400E-03 <CR> <LF>	Status and pressure
T: <ENQ>	Request for data transmission
R: 1,8.0000E-04 <CR> <LF>	Status and pressure

## 6 Maintenance

The product requires no maintenance.

### Cleaning the AGC-100

For cleaning the outside of the AGC-100, a slightly moist cloth will usually do. Do not use any aggressive or scouring cleaning agents.

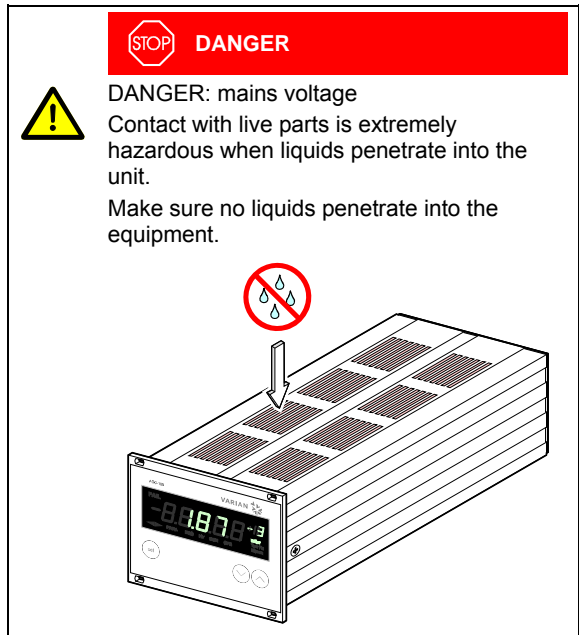



## 7 Troubleshooting



Error indication



**FAIL**  and the error relay opens (→ [23](#)).



Error messages

	Possible cause and remedy/ acknowledgement
	Parameter setup lock activated (→ <a href="#">44</a> ).

	Possible cause and remedy/ acknowledgement
	Interruption or instability in sensor line or connector (Sensor error).
	⇒ Acknowledge with the  key. If the problem persists, <b>noSen</b> or <b>noPd</b> is displayed

  0 ... 9	Possible cause and remedy/ acknowledgement
	Error messages concerning FRG-720. Meaning → <a href="#">[2]</a> . 0 = no communication to the gauge 1...9 = High-Byte of Error-Byte













  x x	Possible cause and remedy/ acknowledgement
	Error messages concerning FRG-730. Meaning → <a href="#">[3]</a> . xx = Error byte (HEX)

	Possible cause and remedy/ acknowledgement
	The AGC-100 has been turned on too fast after power off.
	⇒ Acknowledge with the  key <sup>1)</sup> .
	The watchdog has tripped because of a

severe electric disturbance or an operating system error.

⇒ Acknowledge with the  key <sup>1)</sup>.

<sup>1)</sup> If the watchdog is set to **Auto**, the AGC-100 acknowledges the message automatically after 2 s (→  43).

	Possible cause and remedy/ acknowledgement
	Main memory (RAM) error. ⇒ Acknowledge with the  key.
	Possible cause and remedy/ acknowledgement
	Program memory (EPROM) error. ⇒ Acknowledge with the  key.
	Possible cause and remedy/ acknowledgement
	Parameter memory (EEPROM) error. ⇒ Acknowledge with the  key.
	Possible cause and remedy/ acknowledgement
	Display driver error. ⇒ Acknowledge with the  key.
	Possible cause and remedy/ acknowledgement
	A/D converter error. ⇒ Acknowledge with the  key.
	Possible cause and remedy/ acknowledgement
	Operating system (Task Fail) error. ⇒ Acknowledge with the  key.

Technical support



If the problem persists after the message has been acknowledged for several times and/or the gauge has been exchanged, please contact your local VARIAN service center.

## 8 Repair

Return defective products to your local VARIAN service center for repair.

VARIAN assumes no liability and the warranty becomes null and void if repair work is carried out by the end-user or third parties.

## 9 Accessories

	Ordering number
Adapter panel for installation into a 19" rack chassis adapter, height 3 U	AGC100ADPT

## 10 Storage



### Caution



Caution: electronic component

Inappropriate storage (static electricity, humidity etc.) can damage electronic components.

Store the product in a bag or container. Observe the corresponding specifications in the technical data (→  9).



# 11 Disposal



**WARNING**



**WARNING: substances detrimental to the environment**

Products or parts thereof (mechanical and electric components, operating fluids etc.) can be detrimental to the environment. Dispose of such substances in accordance with the relevant local regulations.

### Separating the components

Non-electronic components

Electronic components

After disassembling the product, separate its components according to the following criteria:

Such components must be separated according to their materials and recycled.

Such components must be separated according to their materials and recycled.

## Appendix

### A: Conversion Tables

#### Weights

	kg	lb	slug	oz
kg	1	2.205	$68.522 \times 10^{-3}$	35.274
lb	0.454	1	$31.081 \times 10^{-3}$	16
slug	14.594	32.174	1	514.785
oz	$28.349 \times 10^{-3}$	$62.5 \times 10^{-3}$	$1.943 \times 10^{-3}$	1

#### Pressures

	N/m <sup>2</sup> , Pa	bar	mbar	Torr	at
N/m <sup>2</sup> , Pa	1	$10 \times 10^{-6}$	$10 \times 10^{-3}$	$7.5 \times 10^{-3}$	$9.869 \times 10^{-6}$
bar	$100 \times 10^3$	1	$10^3$	750.062	0.987
mbar	100	$10^{-3}$	1	$750.062 \times 10^{-3}$	$0.987 \times 10^{-3}$
Torr	133.322	$1.333 \times 10^{-3}$	1.333	1	$1.316 \times 10^{-3}$
at	$101.325 \times 10^3$	1.013	$1.013 \times 10^3$	760	1

#### Pressure units used in the vacuum technology

	mbar	Pascal	Torr	mmWs	psi
mbar	1	100	$750.062 \times 10^{-3}$	10.2	$14.504 \times 10^{-3}$
Pascal	$10 \times 10^{-3}$	1	$7.5 \times 10^{-3}$	0.102	$0.145 \times 10^{-3}$
Torr	1.333	133.322	1	13.595	$19.337 \times 10^{-3}$
mmWs	$9.81 \times 10^{-2}$	9.81	$7.356 \times 10^{-2}$	1	$1.422 \times 10^{-3}$
psi	68.948	$6.895 \times 10^3$	51.715	703	1

#### Linear measures















	mm	m	inch	ft
mm	1	$10^{-3}$	$39.37 \times 10^{-3}$	$3.281 \times 10^{-3}$
m	$10^3$	1	39.37	3.281
inch	25.4	$25.4 \times 10^{-3}$	1	$8.333 \times 10^{-2}$
ft	304.8	0.305	12	1

#### Temperature

	Kelvin	Celsius	Fahrenheit
Kelvin	1	$^{\circ}\text{C} + 273.15$	$(^{\circ}\text{F} + 459.67) \times 5/9$
Celsius	K-273.15	1	$5/9 \times ^{\circ}\text{F} - 17.778$
Fahrenheit	$9/5 \times \text{K} - 459.67$	$9/5 \times (^{\circ}\text{C} + 17.778)$	1

**B: Default Parameters**

The following values are activated when the default parameters are loaded (→  31):

	Default	User
	oFF	
	5×10 <sup>-4</sup> mbar	
	1×10 <sup>3</sup> mbar	
	1000 Torr	
	oFF	
	mbar	
	1.00	
	nor	
	2 digits	
	9600	
	Auto	
	oFF	
	oFF	
	Auto	
	Auto	

## C: Firmware Update



If your AGC-100 firmware needs updating, e.g. for implementing a new gauge type, please contact your local VARIAN service center.

### User parameters

Most of the settings you may have defined in the Parameter and Test mode will not be affected by a firmware update. To be sure, note your parameter settings before upgrading the firmware (→  75).

### Preparing the AGC-100 for a program transfer

- 1** Turn the AGC-100 off
- 2** Connect the AGC-100 with the serial COM1 (COM2) interface of your PC via a 9-pin D-Sub extension cable (the firmware of the AGC-100 cannot be loaded from a Mac).

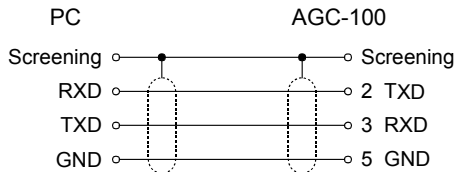

- 3** With a pin ( $\varnothing < 2$  mm) depress the switch behind the rear panel and turn the AGC-100 on.

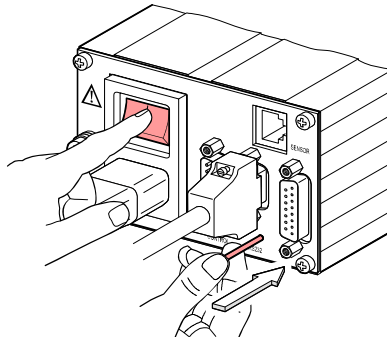

After power on, the display remains dark.

Program transfer

In the following instructions, the index -n is used instead of the actual index.

- 1 Unpack the self extracting file \*.exe or the packed file \*.zip.

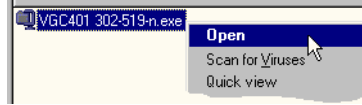

- 2 If you have not connected the AGC-100 to the COM1 interface:

Open the batch file Update 302-564-n.bat, ...

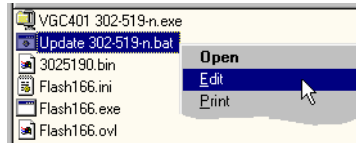

... edit the interface ...



... and save the new setting.

- 3 Start batch file Update 302-564-n.bat.

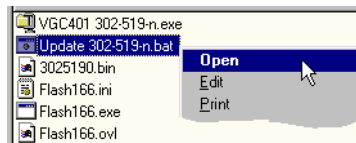

⇒ The new firmware is transmitted to the AGC-100.

```

D:\VGC401\0\Update>FLASH166 /P 302519n.BIN /COM1
FLASH166 --- Utility for 80C166, C16x and ST10 using bootstrap
Copyright (C) FS FORTH-SYSTEME GmbH, Breisach
Version 3.03 of 06/14/2000, limited OEM Version (21279)

Loading bootstrap code (32 Bytes)
Loading target monitor (262 Bytes)
Target monitor located to 00FA40H
Infineon C161PI
CPU clock = 24.115.200 MHz
Configuration loaded from file FLASH166.INI
Target: VGC401, INFICON

WSI PSD813Fx-A/913Fx detected
Loading flash algorithm (138 Bytes)
Erasing Flash-EEPROM Block #:0 1 2 3 4 5 6 7
Programming File 302519n.BIN (131072 Bytes)
131072 Bytes programmed
programming ok

Erase Time      : 9.5 sec
Programming Time: 32.0 sec
    
```

Starting the AGC-100 with the updated firmware







If the program transfer was successful, quit the Update mode by turning the AGC-100 off.



Wait at least 10 s before turning the AGC-100 on again in order for it to correctly initialize itself.

- ✓ The AGC-100 is now ready for operation. To be sure, check that the current parameter settings are identical with the previously defined settings (→  75).

**D: Literature**

-  [1] [www.varianinc.com](http://www.varianinc.com)  
 Instruction Manual  
 Inverted Magnetron Pirani Gauge  
 FRG-700, FRG-702  
 tqna48e1  
 VARIAN Vacuum Technologies  
 MA, 02421 USA
-  [2] [www.varianinc.com](http://www.varianinc.com)  
 Instruction Manual  
 Bayard-Alpert Pirani Gauge  
 FRG-720  
 tqna03e1  
 VARIAN Vacuum Technologies  
 MA, 02421 USA
-  [3] [www.varianinc.com](http://www.varianinc.com)  
 Instruction Manual  
 Bayard-Alpert Pirani Gauge  
 FRG-730  
 tqna46e1  
 VARIAN Vacuum Technologies  
 MA, 02421 USA
-  [4] [www.varianinc.com](http://www.varianinc.com)  
 Instruction Manual  
 Pirani Standard Gauge  
 PVG-500, PVG-502  
 tqna44e1  
 VARIAN Vacuum Technologies  
 MA, 02421 USA
-  [5] [www.varianinc.com](http://www.varianinc.com)  
 Instruction Manual  
 Pirani Capacitance Diaphragm Gauge  
 PCG-750, PCG-752  
 tqna56e1  
 VARIAN Vacuum Technologies  
 MA, 02421 USA
-  [6] [www.varianinc.com](http://www.varianinc.com)  
 Instruction Manual  
 Capacitance Diaphragm Gauge  
 CDG-500  
 tqna49e1  
 VARIAN Vacuum Technologies  
 MA, 02421 USA

## E: Index

A/D converter test	46	Gauges	9
Accessories	72	General parameters	
Baud rate	39	display resolution	39
Calibration factor		pressure units	37
→ Correction factor		I/O test	48
Cleaning	69	Identification of the gauge	28
Communication		Installation	13
Example	68	Interface	→ RS232C
Mnemonics	53	Literature	79
RS232C-	49	Mains power connector	20
Connectors		Maintenance	69
CONTROL	22	Measurement mode	
mains power	20	displaying the gauge identi-	
RS232	24	fication	28
SENSOR	21	Measurement range	35
Contact positions	23	Measurement units	
Contents	4	→ Pressure units	
CONTROL connector	22	Measurement value filter	38
Conversion	74	Mnemonics	→ Communication
Correction factor	37	Mode	→ Operating modes
Default parameters	75	Offset	35
Loading	31	Operating modes	
Default settings	75	Measurement mode	27
Degas	31	overview	26
Display		Parameter mode	29
resolution	39	Program transfer mode	76
Display test	46	Test mode	41
Disposal	73	Operation	
EEPROM	45	power off	26
Emission on/off	40	power on	26
EPROM test	45	Parameter mode	29
Error messages	70	correction factor	37
Factory settings	75	degas	31
Filament	40	display resolution	39
Filter	38	measurement range	35
Firmware		measurement value filter	38
update	76	offset	35
version	2, 43	pressure units	37
Front panel	25	switching thresholds	32
display	25	transmission rate	39
operator keys	25	Parameter Mode	
Full Scale		Emission on/off	40
→ Measurement range		Filament	40
Gauge		Parameter setup lock	44
identification	28	Pin assignment	
Gauge connector	21	CONTROL	23
Gauge parameters		RS232	24
measurement value filter	38	SENSOR	22



Power connector	20	Thresholds	32
Power off	26	Torr lock	44
Power on	26	Transmission rate	39
Pressure units	37	Troubleshooting	70
Program	→ Firmware	Units	→ Pressure units
RAM test	44	Update	76
Repair	72	Warranty	8
RS232C		Watchdog	43
interface connector	24		
Serial interface	24		
Technical data	12		
Test	48		
Safety	6		
Scope of Delivery	3		
SENSOR connector	21		
Serial interface	→ RS232C		
Storage	72		
Switching function	32		
Symbols	6		
Technical data	9		
Test	45		
Test mode			
A/D converter test	46		
Display test	46		
EPROM test	45		
Firmware version	43		
I/O test	48		
parameter setup lock	44		
RAM test	44		
RS232C test	48		
Torr lock	44		
Watchdog	43		

**EC Declaration of Conformity**



We, VARIAN, hereby declare that the equipment mentioned below complies with the provisions of the Directive relating to electrical equipment designed for use within certain voltage limits 2006/95/EC and the Directive relating to electromagnetic compatibility 2004/108/EC.

Product

Vacuum Gauge Controller  
AGC-100

Standards

Harmonized and international/national standards and specifications:

- EN 61010-1:2001 (Safety requirements for electrical equipment for measurement, control and laboratory use)
- EN 61000-3-2:2006 (EMC: limits for harmonic current emissions)
- EN 61000-3-3:1995 + A1:2001 + A2:2005 (EMC: limitation of voltage changes, voltage fluctuations and flicker)
- EN 61000-6-2:2005 (EMC: generic immunity standard)
- EN 61000-6-3:2007 (EMC: generic emission standard)

Manufacturer / Signatures

Varian Vacuum Technologies, 121 Hartwell Avenue,  
Lexington, MA, 02421 USA

19 May 2010



John Ehmann  
General Manager

## Notes



211 Hatwell Avenue  
Lexington, MA, 02421 USA  
Tel: (781) 861 7200  
Fax: (781) 861 5437  
custserv@varianinc.com

[www.varianinc.com](http://www.varianinc.com)



tqnb01e1-a